

STEEL TREADPLATE TOOLBOX W/FORK POCKETS & CASTERS - STTB-3660-CF

APPROX WEIGHT: 412.74 lbs.
 DOES NOT INCLUDE WEIGHT OF POWER OR PACKAGING!!!

*** ANY ADDITIONS, DELETIONS, OR OMISSIONS MUST BE CORRECTED ON THIS DRAWING AS THIS DRAWING WILL BE CONSIDERED ALL INCLUSIVE ***
 ALL GRAPHICS PROVIDED ARE FOR REFERENCE ONLY. IF CERTAIN DIMENSIONS ARE CRITICAL PLEASE VERIFY THOSE DIMENSIONS WITH YOUR SALESPERSON

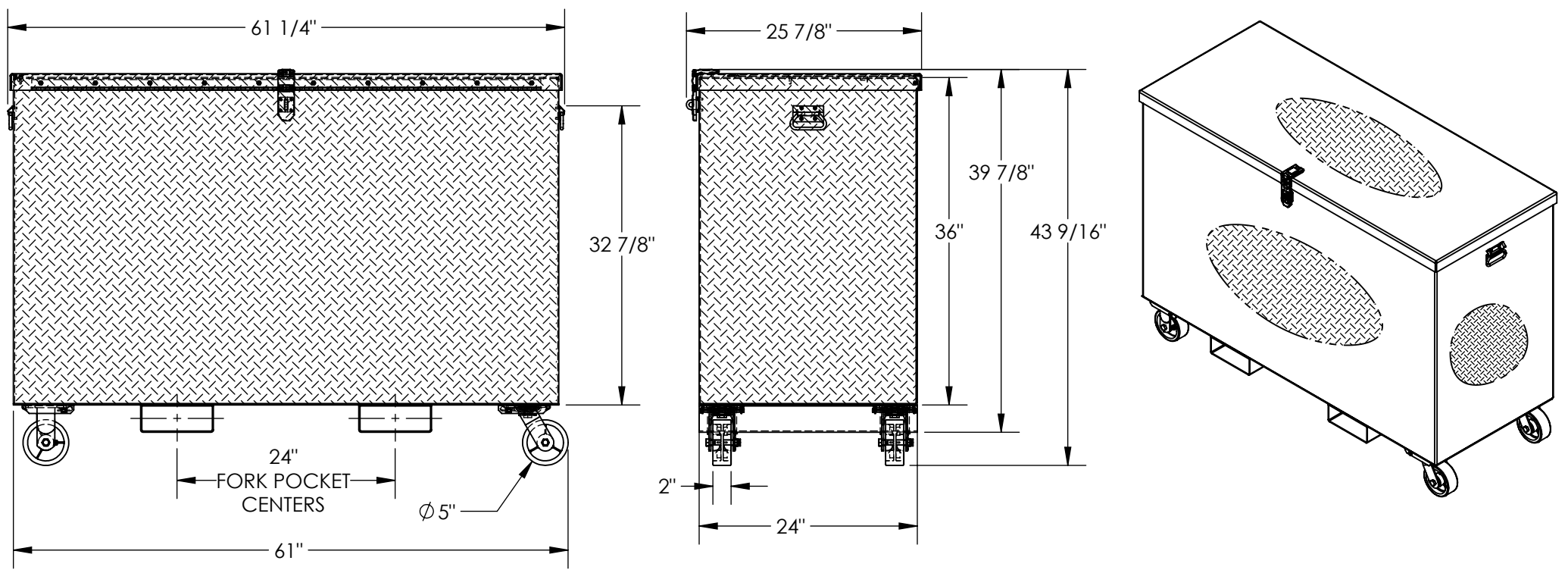

DIMENSION TOLERANCE ± 1/4"

STANDARD FEATURES

- MODEL NUMBER IS STTB-3660-CF
- OVERALL WIDTH IS 61 1/4"
- USABLE WIDTH IS 61"
- OVERALL DEPTH IS 43 9/16"
- USABLE DEPTH IS 24"
- OVERALL HEIGHT IS 39 7/8"
- USABLE HEIGHT IS 36"
- MAX CAPACITY IS 3000 LBS.
- TOUGH BAKED IN POWDER COAT BLACK FINISH
- 24" FORK POCKET CENTERS
- CASTERS ARE 5" x 2" POLY ON STEEL
- 2 SWIVEL, 2 RIGID

SPECIAL FEATURES

NONE

APPROVAL

I, THE UNDERSIGNED, AGREE THAT THE PRODUCT AS REPRESENTED SATISFIES DESIGN AND DIMENSION REQUIREMENTS. I ALSO ACKNOWLEDGE MY DUTY TO CONFIRM PRODUCT AND INSTALLATION COMPLIANCE WITH ALL APPLICABLE FEDERAL, STATE AND LOCAL REGULATIONS AND STANDARDS.

UNITS REQUIRING APPROVAL DRAWINGS OR MODIFIED ARE NON-RETURNABLE

As drawn As marked

Signed: _____ Date: _____

Printed Name: _____

LEAD TIME WILL START UPON RECEIPT OF SIGNED APPROVAL DRAWING

DISTRIBUTOR'S NAME:		P.O.#
VESTIL MANUFACTURING		X
DRAWN BY: C.CLEMENS		W.O.#
DATE: 1/5/2021		X
REFERENCE: X	SCALE: 1:16	SALES: X
QUOTED LEAD TIME: X	QUOTE #	FILE NAME:
	X	41-007-061