

SPECIAL CARRIAGE MOUNTED COIL RAM - CCM-36-4-CL3

APPROX WEIGHT: 134.47 lbs.
DOES NOT INCLUDE WEIGHT OF POWER OR PACKAGING!!!

*** ANY ADDITIONS, DELETIONS, OR OMISSIONS MUST BE CORRECTED ON THIS DRAWING AS THIS DRAWING WILL BE CONSIDERED ALL INCLUSIVE ***
ALL GRAPHICS PROVIDED ARE FOR REFERENCE ONLY. IF CERTAIN DIMENSIONS ARE CRITICAL PLEASE VERIFY THOSE DIMENSIONS WITH YOUR SALESPERSON

STANDARD FEATURES

MODEL NUMBER IS CCM-36-4-CL3
OVERALL WIDTH IS 12"
OVERALL LENGTH IS 43 1/2"
USABLE RAM LENGTH IS 36"
OVERALL HEIGHT IS 24 1/2"
UNIFORM CAPACITY IS 3,000 LBS.
RAM O.D. IS 4 1/2"
FITS STANDARD CLASS III CARRIAGE

HORIZONTAL CENTER OF GRAVITY: 12.77"
VERTICAL CENTER OF GRAVITY: 8.79"
EFFECTIVE THICKNESS: LESS THAN 1"
LOST LOAD: 134.47 lbs.

SPECIAL FEATURES

NONE

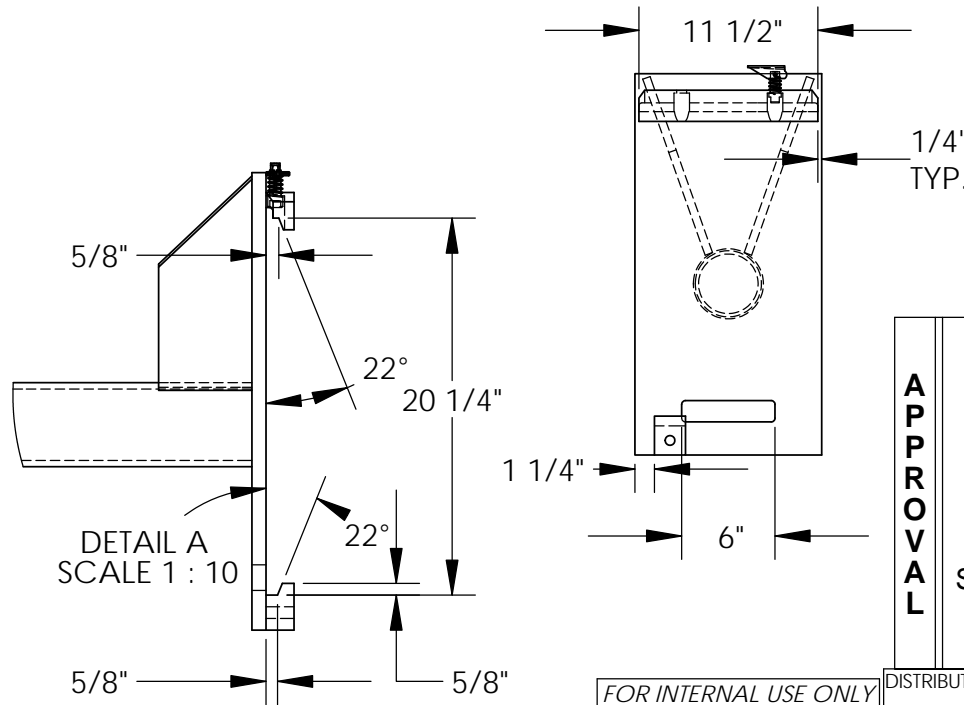
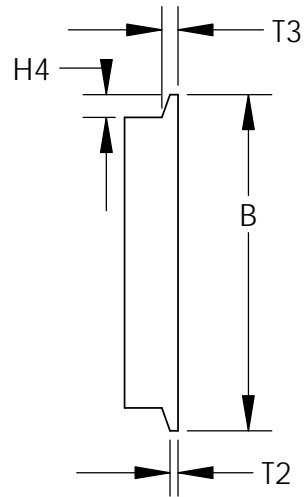
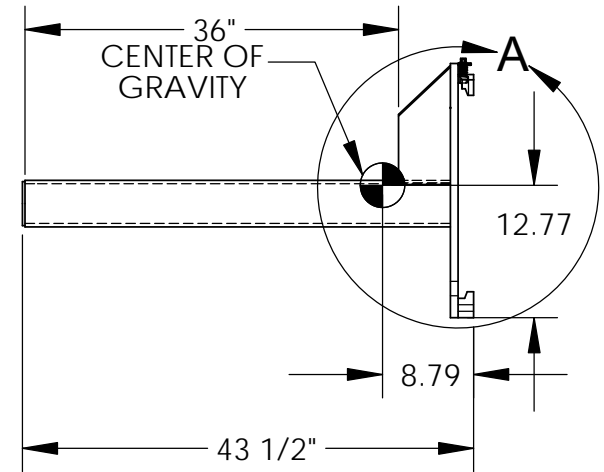
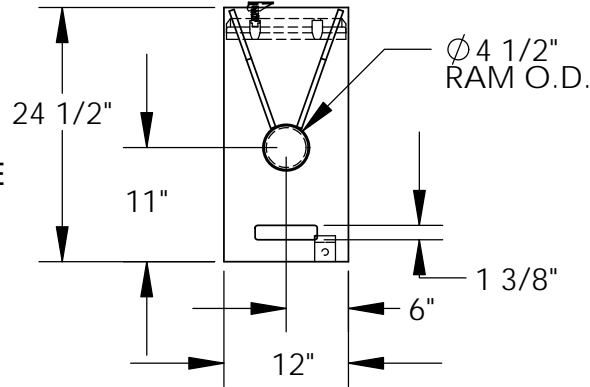

DIMENSION TOLERANCE ± 1/4"

I, THE UNDERSIGNED, AGREE THAT THE PRODUCT AS REPRESENTED SATISFIES DESIGN AND DIMENSION REQUIREMENTS. I ALSO ACKNOWLEDGE MY DUTY TO CONFIRM PRODUCT AND INSTALLATION COMPLIANCE WITH ALL APPLICABLE FEDERAL, STATE AND LOCAL REGULATIONS AND STANDARDS.
ALL SPECIAL UNITS ARE NON-RETURNABLE
[] As drawn [] As marked

APPROVAL

Signed: _____ Date: _____

LEAD TIME WILL START UPON RECEIPT OF SIGNED APPROVAL DRAWING

***NOTE**
DUE TO VARIATIONS IN FORK TRUCK CARRIAGES, PLEASE HAVE THE CUSTOMER VERIFY THAT THEIR CARRIAGE WILL CONFORM TO THE DIMENSIONS SHOWN TO THE RIGHT. IF NOT, PLEASE HAVE THE CUSTOMER VERIFY DIMENSIONS B, T2, T3, & H4 TO BE ABLE TO QUOTE A SPECIAL BACKPLATE TO FIT.

FOR INTERNAL USE ONLY PROJECT SIGN OFF	
SALES	
ENG.	
FAB.	
POWER	

DISTRIBUTOR'S NAME: VESTIL MANUFACTURING		P.O.# X
DRAWN BY: B.NOTHNAGEL		W.O.# X
DATE: 02/04/2015	SALES: X	FILE NAME:
REFERENCE: X	SCALE: 1:16	08-007-279
QUOTED LEAD TIME: X	QUOTE # X	