

LOW PROFILE SCISSOR TABLE - EHLTX-4853-3-39

APPROX WEIGHT: 802.95 lbs.
 DOES NOT INCLUDE WEIGHT OF POWER OR PACKAGING!!!

*** ANY ADDITIONS, DELETIONS, OR OMISSIONS MUST BE CORRECTED ON THIS DRAWING AS THIS DRAWING WILL BE CONSIDERED ALL INCLUSIVE ***

ALL GRAPHICS PROVIDED ARE FOR REFERENCE ONLY. IF CERTAIN DIMENSIONS ARE CRITICAL PLEASE VERIFY THOSE DIMENSIONS WITH YOUR SALESPERSON

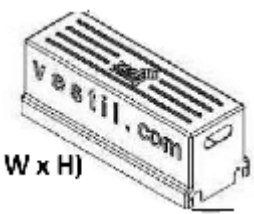
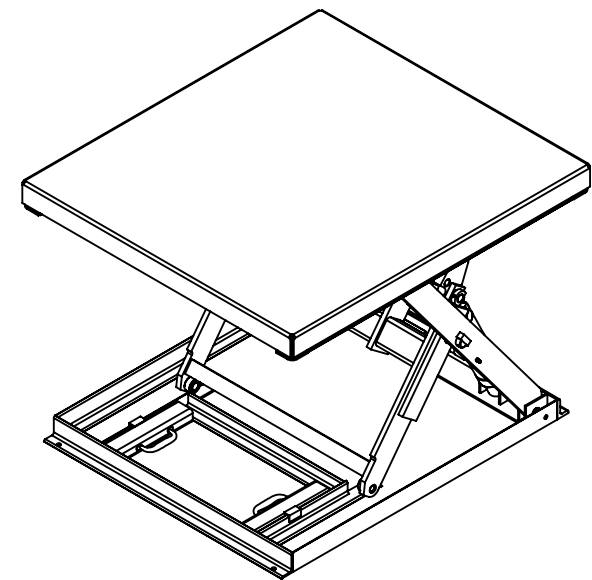
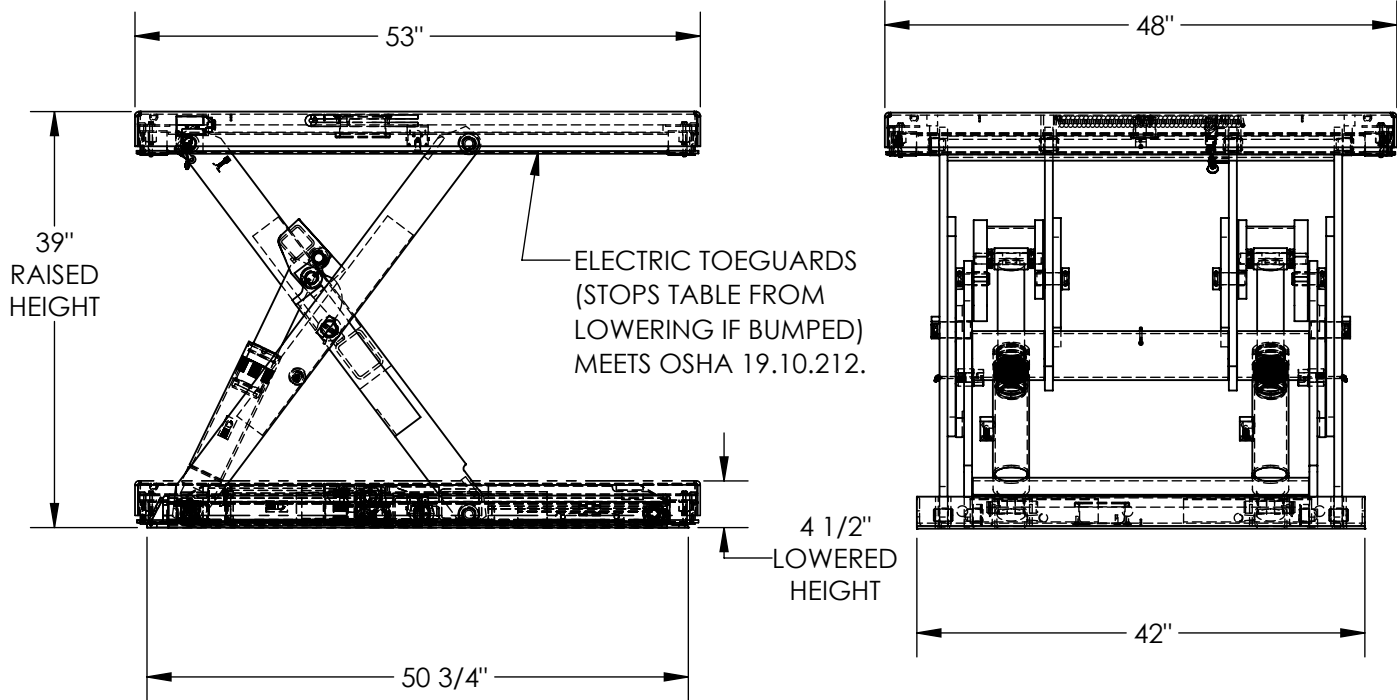

REMOTE POWER UNIT
 32 1/2" x 12" x 12 1/2" (L x W x H)
 WITH 8' HOSE & CABLE

PLEASE CIRCLE SPECIFICATIONS:

POWER	AC	DC (12V)	AIR/OIL
MOTOR VOLTAGE	115	208	230 460
DEDICATED CIRCUIT REQUIRED 60Hz			
MOTOR PHASE	SINGLE	THREE	
CONTROL	HAND	FOOT	

DECK TOLERANCE ± 1/2"
 TABLE HEIGHT TOLERANCE ± 1/2"
 DECK FLATNESS ± 1/4"

DIMENSION TOLERANCE ± 1/4"

NOTE:
 * MOST DECK ADDITIONS DERATE THE TABLE BY AT LEAST 250 LBS

STANDARD FEATURES

- MODEL NUMBER IS EHLTX-4853-3-39
- PLATFORM WIDTH IS 48"
- PLATFORM LENGTH IS 53"
- BASE WIDTH IS 42"
- BASE LENGTH IS 50 3/4"
- PLATFORM RAISED HEIGHT IS 39"
- PLATFORM LOWERED HEIGHT IS 4 1/2"
- MAX CAPACITY IS 3,000 LBS
- HAND CONTROL RAIN TIGHT ON 8' CORD
- DURABLE LIQUID PAINT BLUE FINISH

SPECIAL FEATURES

NONE

APPROVAL

I, THE UNDERSIGNED, AGREE THAT THE PRODUCT AS REPRESENTED SATISFIES DESIGN AND DIMENSION REQUIREMENTS. I ALSO ACKNOWLEDGE MY DUTY TO CONFIRM PRODUCT AND INSTALLATION COMPLIANCE WITH ALL APPLICABLE FEDERAL, STATE AND LOCAL REGULATIONS AND STANDARDS.

ANY MODIFIED UNITS ARE NON-RETURNABLE

[] As drawn [] As marked

Signed: _____ Date: _____

Printed Name: _____

LEAD TIME WILL START UPON RECEIPT OF SIGNED APPROVAL DRAWING

FOR INTERNAL USE ONLY
 PROJECT SIGN OFF

SALES	
ENG.	
FAB.	
POWER	

DISTRIBUTOR'S NAME:		P.O.#
VESTIL MANUFACTURING		X
DRAWN BY: BCN	DATE: 1/12/2018	W.O.#
REFERENCE: X	SCALE: 1:18	X
QUOTED LEAD TIME: X	QUOTE #	FILE NAME:
	X	27-007-151-003