

LOW PROFILE SCISSOR TABLE - EHLTX-4856-2-39

APPROX WEIGHT: 837.58 lbs.
DOES NOT INCLUDE WEIGHT OF POWER OR PACKAGING!!!

*** ANY ADDITIONS, DELETIONS, OR OMISSIONS MUST BE CORRECTED ON THIS DRAWING AS THIS DRAWING WILL BE CONSIDERED ALL INCLUSIVE ***
ALL GRAPHICS PROVIDED ARE FOR REFERENCE ONLY. IF CERTAIN DIMENSIONS ARE CRITICAL PLEASE VERIFY THOSE DIMENSIONS WITH YOUR SALESPERSON

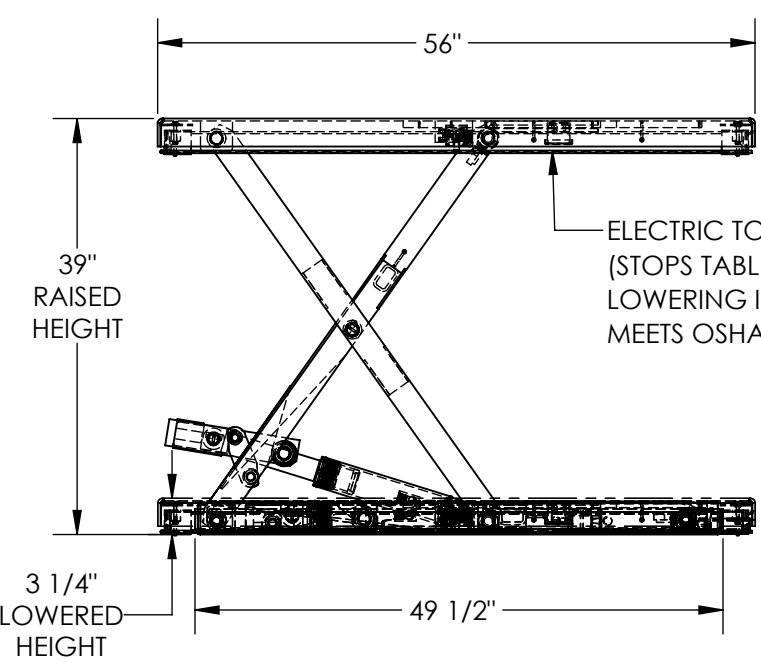

ELECTRIC TOEGUARDS
(STOPS TABLE FROM LOWERING IF BUMPED)
MEETS OSHA 19.10.212.

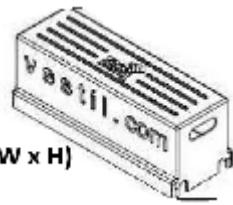
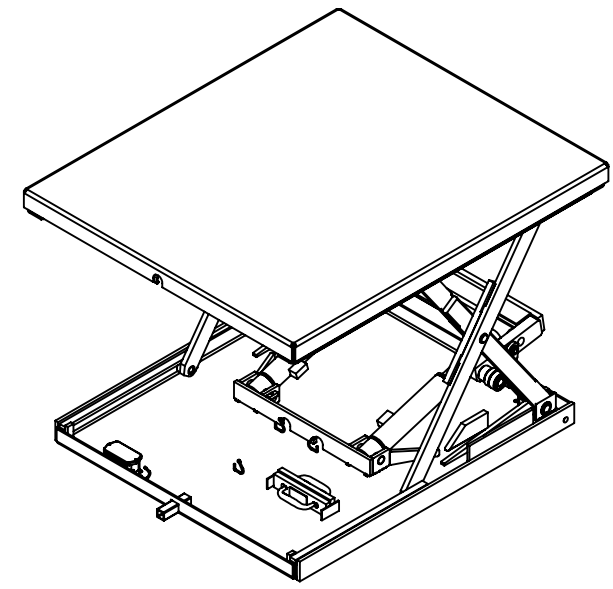
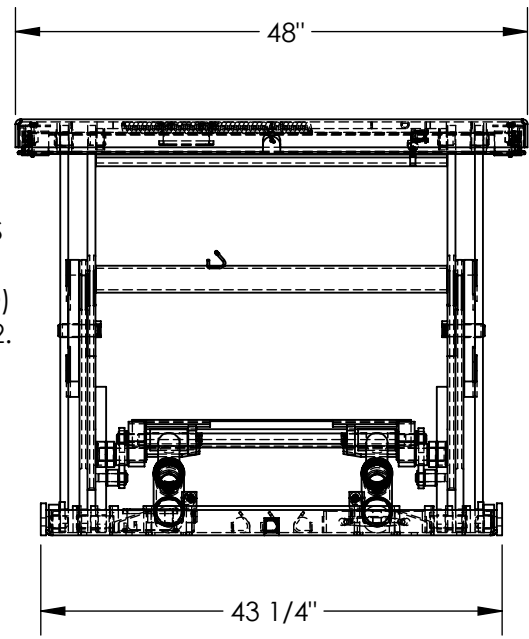

REMOTE POWER UNIT
32 1/2" x 12" x 12 1/2" (L x W x H)
WITH 8' HOSE & CABLE

DIMENSION TOLERANCE ± 1/4"

NOTE:
* MOST DECK ADDITIONS DERATE THE TABLE BY AT LEAST 250 LBS

PLEASE CIRCLE SPECIFICATIONS:

POWER	AC	DC (12V)	AIR/OIL
MOTOR VOLTAGE	115	208	230 460
DEDICATED CIRCUIT REQUIRED 60Hz			
MOTOR PHASE	SINGLE	THREE	
CONTROL	HAND	FOOT	

DECK TOLERANCE ± 1/2"
TABLE HEIGHT TOLERANCE ± 1/2"
DECK FLATNESS ± 1/4"

STANDARD FEATURES

- MODEL NUMBER IS EHLTX-4856-2-39
- PLATFORM WIDTH IS 48"
- PLATFORM LENGTH IS 56"
- BASE WIDTH IS 43 3/4"
- BASE LENGTH (WITHOUT ELECTRIC CORD TUBE) IS 49 1/2"
- UNIT LENGTH = PLATFORM LENGTH + 3/8"
- PLATFORM RAISED HEIGHT IS 39"
- PLATFORM LOWERED HEIGHT IS 3 1/4"
- MAX CAPACITY IS 2,000 LBS
- HAND CONTROL RAIN TIGHT ON 8' CORD
- DURABLE LIQUID PAINT BLUE FINISH

SPECIAL FEATURES

NONE

APPROVAL

I, THE UNDERSIGNED, AGREE THAT THE PRODUCT AS REPRESENTED SATISFIES DESIGN AND DIMENSION REQUIREMENTS. I ALSO ACKNOWLEDGE MY DUTY TO CONFIRM PRODUCT AND INSTALLATION COMPLIANCE WITH ALL APPLICABLE FEDERAL, STATE AND LOCAL REGULATIONS AND STANDARDS.

ANY MODIFIED UNITS ARE NON-RETURNABLE

[] As drawn [] As marked

Signed: _____ Date: _____

Printed Name: _____

LEAD TIME WILL START UPON RECEIPT OF SIGNED APPROVAL DRAWING

FOR INTERNAL USE ONLY
PROJECT SIGN OFF

SALES	
ENG.	
FAB.	
POWER	

DISTRIBUTOR'S NAME:		P.O.#
VESTIL MANUFACTURING		X
DRAWN BY: BCN	DATE: 10/25/2016	W.O.#
REFERENCE: X	SCALE: 1:18	X
QUOTED LEAD TIME: X	QUOTE #	FILE NAME:
	X	27-007-131-001