

# LOW PROFILE SCISSOR TABLE - EHLTX-5454-2-39

APPROX WEIGHT: 855.29 lbs.  
DOES NOT INCLUDE WEIGHT OF POWER OR PACKAGING!!!

\*\*\* ANY ADDITIONS, DELETIONS, OR OMISSIONS MUST BE CORRECTED ON THIS DRAWING AS THIS DRAWING WILL BE CONSIDERED ALL INCLUSIVE \*\*\*

ALL GRAPHICS PROVIDED ARE FOR REFERENCE ONLY. IF CERTAIN DIMENSIONS ARE CRITICAL PLEASE VERIFY THOSE DIMENSIONS WITH YOUR SALESPERSON

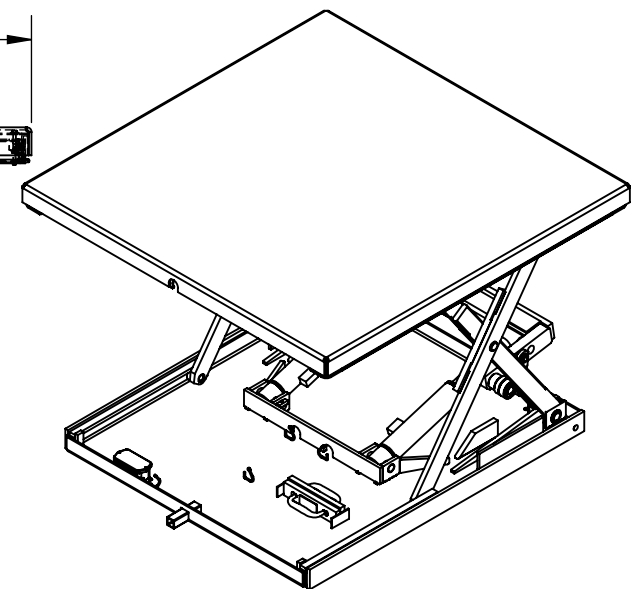
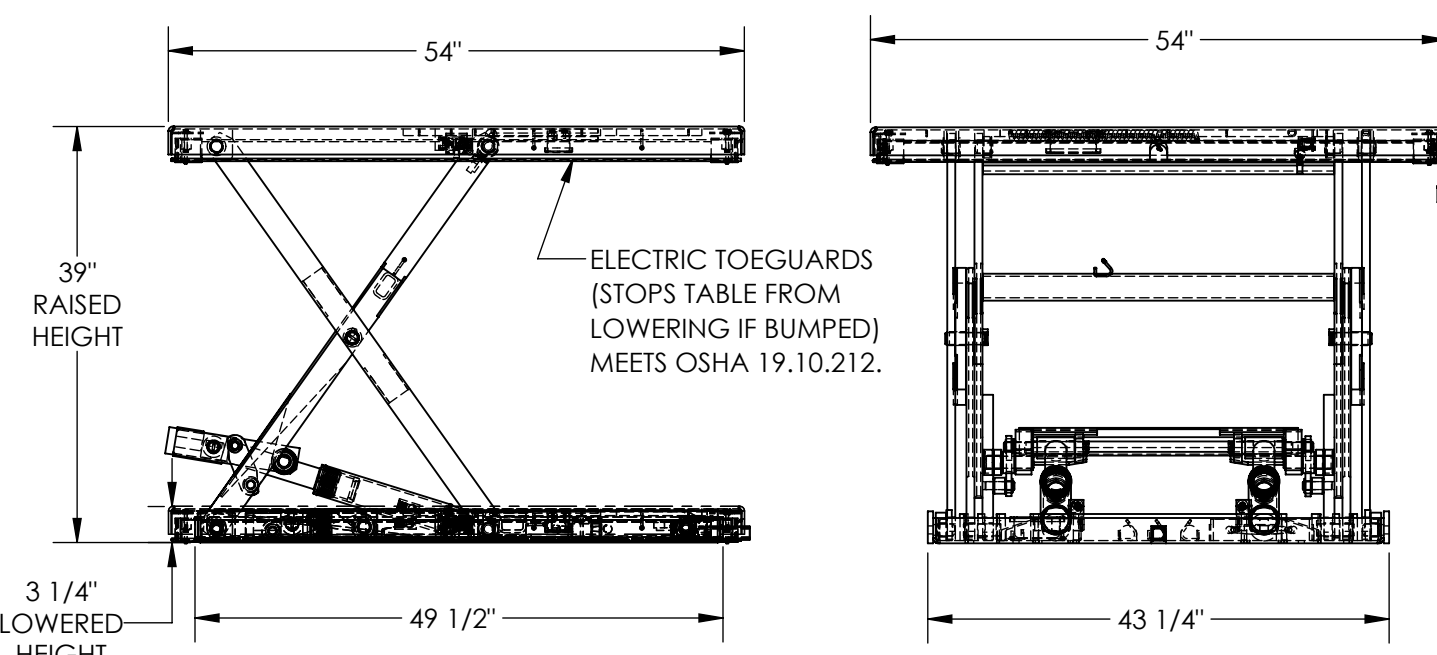

**REMOTE POWER UNIT**  
32 1/2" x 12" x 12 1/2" (L x W x H)  
WITH 8' HOSE & CABLE

DIMENSION TOLERANCE ± 1/4"

**NOTE:**  
\* MOST DECK ADDITIONS DERATE THE TABLE BY AT LEAST 250 LBS

**PLEASE CIRCLE SPECIFICATIONS:**

POWER	AC	<del>DC (12V)</del>	<del>AIR/OIL</del>
MOTOR VOLTAGE	<del>115</del>	<del>208</del>	<del>230</del> 460
DEDICATED CIRCUIT REQUIRED 60Hz			
MOTOR PHASE	<del>SINGLE</del>	THREE	
CONTROL	HAND	<del>FOOT</del>	

DECK TOLERANCE ± 1/2"  
TABLE HEIGHT TOLERANCE ± 1/2"  
DECK FLATNESS ± 1/4"

**STANDARD FEATURES**

- MODEL NUMBER IS EHLTX-5454-2-39
- PLATFORM WIDTH IS 54"
- PLATFORM LENGTH IS 54"
- BASE WIDTH IS 43 3/4"
- BASE LENGTH (WITHOUT ELECTRIC CORD TUBE) IS 49 1/2"
- UNIT LENGTH = PLATFORM LENGTH + 3/8"
- PLATFORM RAISED HEIGHT IS 39"
- PLATFORM LOWERED HEIGHT IS 3 1/4"
- MAX CAPACITY IS 2,000 LBS
- HAND CONTROL RAIN TIGHT ON 8' CORD
- DURABLE LIQUID PAINT BLUE FINISH

**SPECIAL FEATURES**

NONE

**APPROVAL**

I, THE UNDERSIGNED, AGREE THAT THE PRODUCT AS REPRESENTED SATISFIES DESIGN AND DIMENSION REQUIREMENTS. I ALSO ACKNOWLEDGE MY DUTY TO CONFIRM PRODUCT AND INSTALLATION COMPLIANCE WITH ALL APPLICABLE FEDERAL, STATE AND LOCAL REGULATIONS AND STANDARDS.

**ANY MODIFIED UNITS ARE NON-RETURNABLE**

[ ] As drawn      [ ] As marked

Signed: \_\_\_\_\_ Date: \_\_\_\_\_

Printed Name: \_\_\_\_\_

**LEAD TIME WILL START UPON RECEIPT OF SIGNED APPROVAL DRAWING**

FOR INTERNAL USE ONLY  
PROJECT SIGN OFF

SALES	
ENG.	
FAB.	
POWER	

DISTRIBUTOR'S NAME:		P.O.#
VESTIL MANUFACTURING		X
DRAWN BY: BCN	DATE: 10/25/2016	W.O.#
REFERENCE: X	SCALE: 1:18	X
QUOTED LEAD TIME: X	QUOTE #	FILE NAME:
	X	27-007-131-004