

LOW PROFILE SCISSOR TABLE - EHLTX-5656-1-39

APPROX WEIGHT: 872.87 lbs.
DOES NOT INCLUDE WEIGHT OF POWER OR PACKAGING!!!

*** ANY ADDITIONS, DELETIONS, OR OMISSIONS MUST BE CORRECTED ON THIS DRAWING AS THIS DRAWING WILL BE CONSIDERED ALL INCLUSIVE ***

ALL GRAPHICS PROVIDED ARE FOR REFERENCE ONLY. IF CERTAIN DIMENSIONS ARE CRITICAL PLEASE VERIFY THOSE DIMENSIONS WITH YOUR SALESPERSON

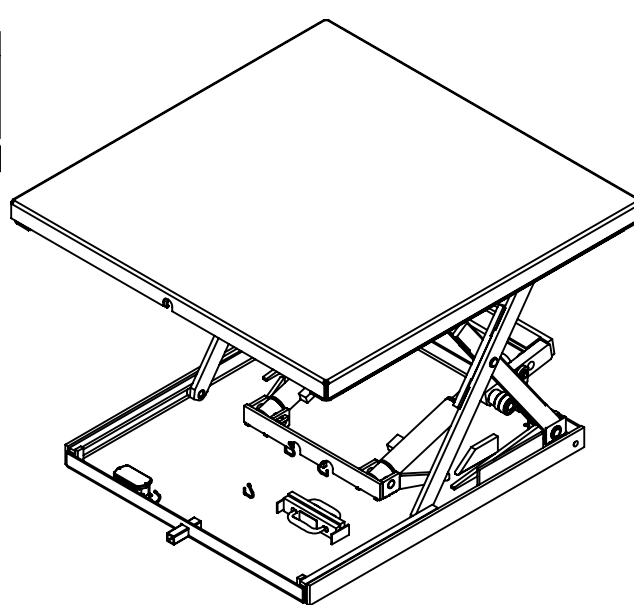
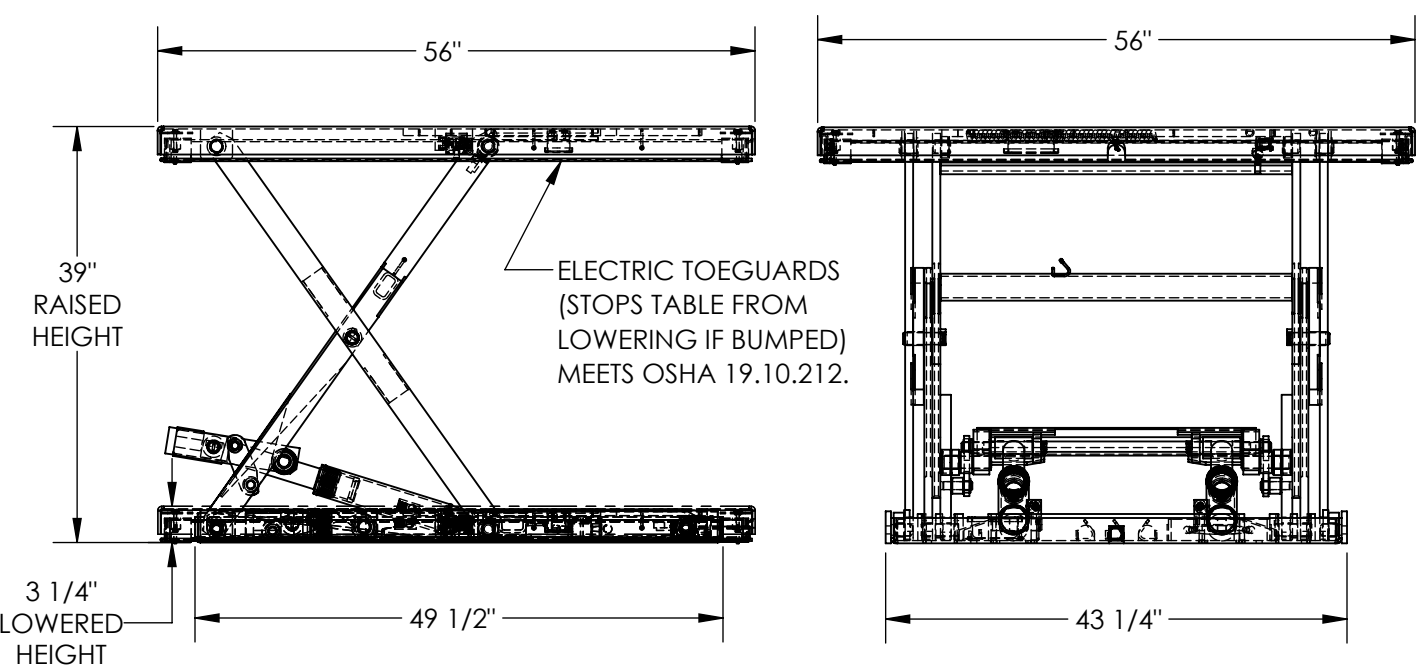

REMOTE POWER UNIT
32 1/2" x 12" x 12 1/2" (L x W x H)
WITH 8' HOSE & CABLE

PLEASE CIRCLE SPECIFICATIONS:

POWER	AC	DC (12V)	AIR/OIL
MOTOR VOLTAGE	115	208	230 460
DEDICATED CIRCUIT REQUIRED 60Hz			
MOTOR PHASE	SINGLE	THREE	
CONTROL	HAND	FOOT	

DECK TOLERANCE ± 1/2"
TABLE HEIGHT TOLERANCE ± 1/2"
DECK FLATNESS ± 1/4"

NOTE:
* MOST DECK ADDITIONS DERATE THE TABLE BY AT LEAST 250 LBS

STANDARD FEATURES

- MODEL NUMBER IS EHLTX-5656-1-39
- PLATFORM WIDTH IS 56"
- PLATFORM LENGTH IS 56"
- BASE WIDTH IS 43 3/4"
- BASE LENGTH (WITHOUT ELECTRIC CORD TUBE) IS 49 1/2"
- UNIT LENGTH = PLATFORM LENGTH + 3/8"
- PLATFORM RAISED HEIGHT IS 39"
- PLATFORM LOWERED HEIGHT IS 3 1/4"
- MAX CAPACITY IS 1,000 LBS
- HAND CONTROL RAIN TIGHT ON 8' CORD
- DURABLE LIQUID PAINT BLUE FINISH

SPECIAL FEATURES

NONE

DIMENSION TOLERANCE ± 1/4"

APPROVAL

I, THE UNDERSIGNED, AGREE THAT THE PRODUCT AS REPRESENTED SATISFIES DESIGN AND DIMENSION REQUIREMENTS. I ALSO ACKNOWLEDGE MY DUTY TO CONFIRM PRODUCT AND INSTALLATION COMPLIANCE WITH ALL APPLICABLE FEDERAL, STATE AND LOCAL REGULATIONS AND STANDARDS.

ANY MODIFIED UNITS ARE NON-RETURNABLE

[] As drawn [] As marked

Signed: _____ Date: _____

Printed Name: _____

LEAD TIME WILL START UPON RECEIPT OF SIGNED APPROVAL DRAWING

FOR INTERNAL USE ONLY
PROJECT SIGN OFF

SALES	
ENG.	
FAB.	
POWER	

DISTRIBUTOR'S NAME:		P.O.#
VESTIL MANUFACTURING		X
DRAWN BY: BCN	DATE: 10/25/2016	W.O.#
REFERENCE: X	SCALE: 1:18	X
QUOTED LEAD TIME: X	QUOTE #	FILE NAME:
	X	27-007-111-008