

# LOW PROFILE SCISSOR TABLE - EHLTX-6053-2-39

APPROX WEIGHT: 876.38 lbs.  
DOES NOT INCLUDE WEIGHT OF POWER OR PACKAGING!!!

\*\*\* ANY ADDITIONS, DELETIONS, OR OMISSIONS MUST BE CORRECTED ON THIS DRAWING AS THIS DRAWING WILL BE CONSIDERED ALL INCLUSIVE \*\*\*

ALL GRAPHICS PROVIDED ARE FOR REFERENCE ONLY. IF CERTAIN DIMENSIONS ARE CRITICAL PLEASE VERIFY THOSE DIMENSIONS WITH YOUR SALESPERSON

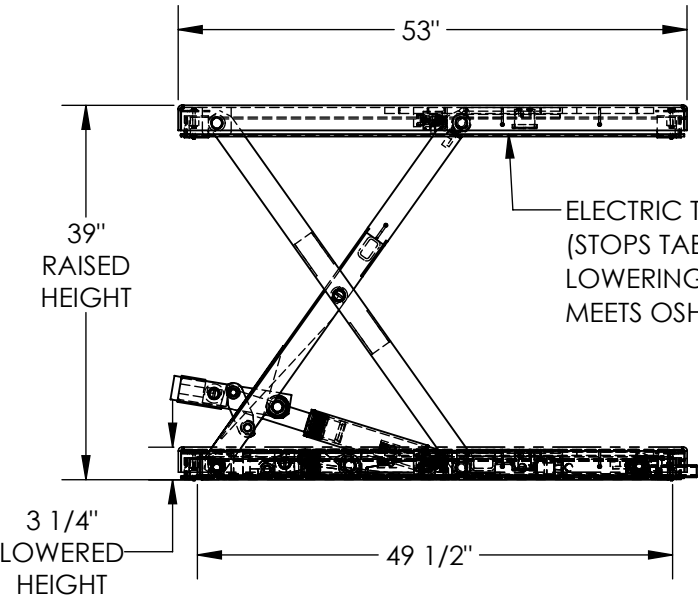

ELECTRIC TOEGUARDS  
(STOPS TABLE FROM  
LOWERING IF BUMPED)  
MEETS OSHA 19.10.212.

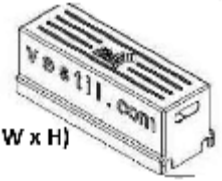
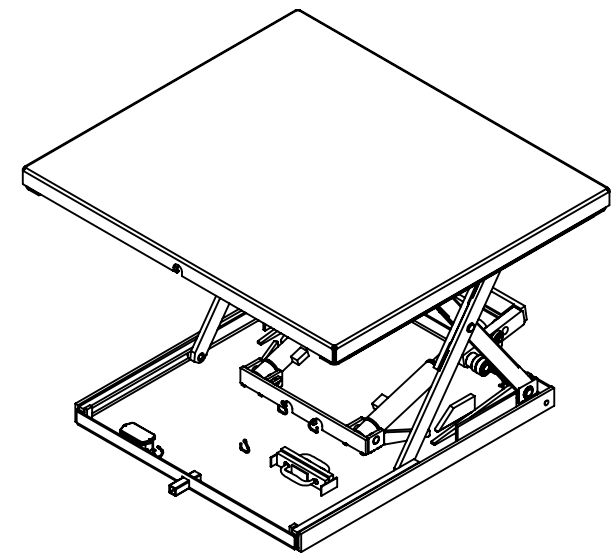
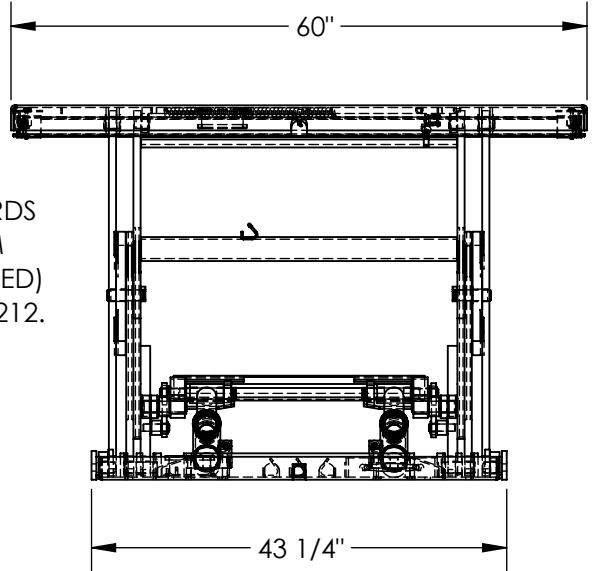

REMOTE POWER UNIT  
32 1/2" x 12" x 12 1/2" (L x W x H)  
WITH 8' HOSE & CABLE

**NOTE:**  
\* MOST DECK ADDITIONS DERATE  
THE TABLE BY AT LEAST 250 LBS

### PLEASE CIRCLE SPECIFICATIONS:

POWER	AC	<del>DC (12V)</del>	<del>AIR/OIL</del>
MOTOR VOLTAGE	<del>115</del>	<del>208</del>	<del>230</del> 460
DEDICATED CIRCUIT REQUIRED 60Hz			
MOTOR PHASE	<del>SINGLE</del>	THREE	
CONTROL	HAND	<del>FOOT</del>	

DECK TOLERANCE ± 1/2"  
TABLE HEIGHT TOLERANCE ± 1/2"  
DECK FLATNESS ± 1/4"

### STANDARD FEATURES

- MODEL NUMBER IS EHLTX-6053-2-39
- PLATFORM WIDTH IS 60"
- PLATFORM LENGTH IS 53"
- BASE WIDTH IS 43 3/4"
- BASE LENGTH (WITHOUT ELECTRIC CORD TUBE) IS 49 1/2"
- UNIT LENGTH = PLATFORM LENGTH + 3/8"
- PLATFORM RAISED HEIGHT IS 39"
- PLATFORM LOWERED HEIGHT IS 3 1/4"
- MAX CAPACITY IS 2,000 LBS
- HAND CONTROL RAIN TIGHT ON 8' CORD
- DURABLE LIQUID PAINT BLUE FINISH

### SPECIAL FEATURES

NONE

DIMENSION TOLERANCE ± 1/4"

**APPROVAL**

I, THE UNDERSIGNED, AGREE THAT THE PRODUCT AS REPRESENTED SATISFIES DESIGN AND DIMENSION REQUIREMENTS. I ALSO ACKNOWLEDGE MY DUTY TO CONFIRM PRODUCT AND INSTALLATION COMPLIANCE WITH ALL APPLICABLE FEDERAL, STATE AND LOCAL REGULATIONS AND STANDARDS.

**ANY MODIFIED UNITS ARE NON-RETURNABLE**

[ ] As drawn      [ ] As marked

Signed: \_\_\_\_\_ Date: \_\_\_\_\_

Printed Name: \_\_\_\_\_

**LEAD TIME WILL START UPON RECEIPT OF SIGNED APPROVAL DRAWING**

FOR INTERNAL USE ONLY  
PROJECT SIGN OFF

SALES	
ENG.	
FAB.	
POWER	

DISTRIBUTOR'S NAME:		P.O.#
VESTIL MANUFACTURING		X
DRAWN BY: BCN	DATE: 10/25/2016	W.O.#
REFERENCE: X	SCALE: 1:20	X
QUOTED LEAD TIME: X	QUOTE #	FILE NAME:
	X	27-007-131-006