

STANDARD SLOPE LADDER, 2-STEP, GRIP STRUT - LAD-PW-26-2-G

APPROX WEIGHT: 61.42 lbs.
DOES NOT INCLUDE WEIGHT OF POWER OR PACKAGING!!!

*** ANY ADDITIONS, DELETIONS, OR OMISSIONS MUST BE CORRECTED ON THIS DRAWING AS THIS DRAWING WILL BE CONSIDERED ALL INCLUSIVE ***

ALL GRAPHICS PROVIDED ARE FOR REFERENCE ONLY. IF CERTAIN DIMENSIONS ARE CRITICAL PLEASE VERIFY THOSE DIMENSIONS WITH YOUR SALESPERSON

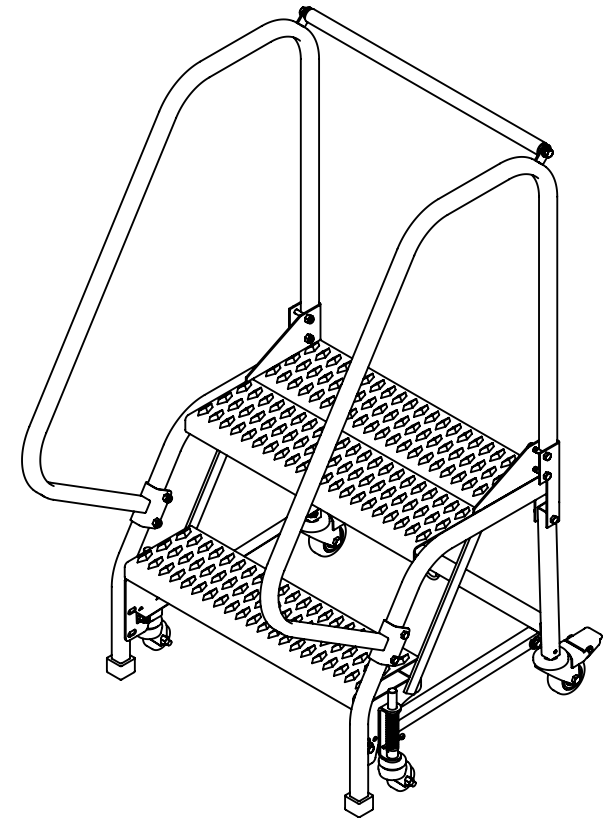
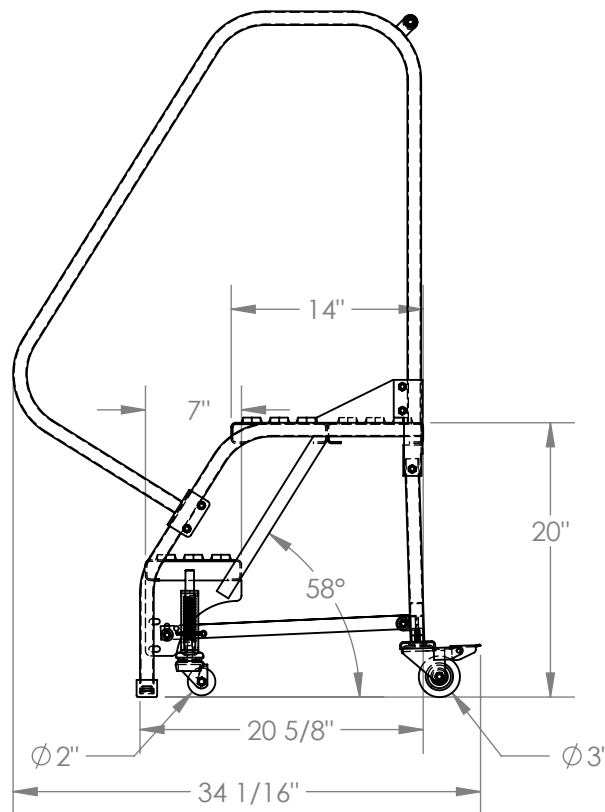
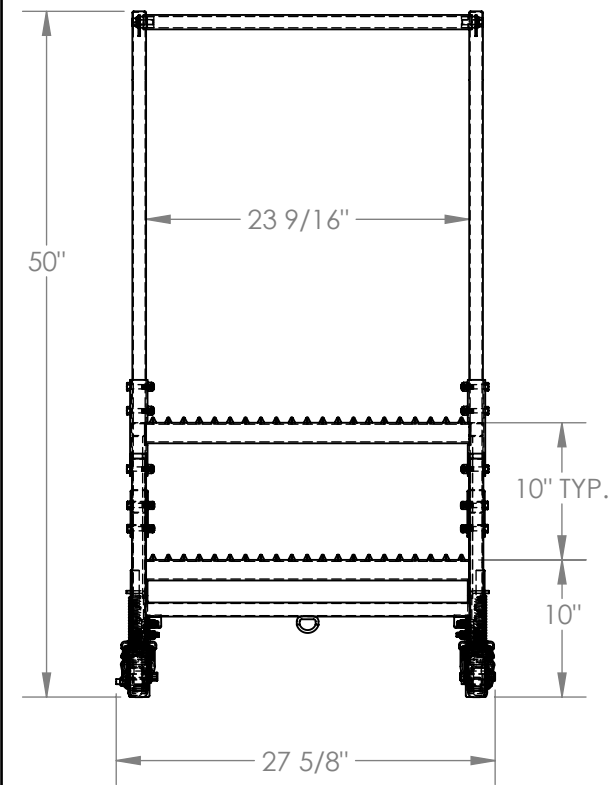

DIMENSION TOLERANCE ± 1/4"

STANDARD FEATURES

- MODEL NUMBER IS LAD-PW-26-2-G
- OVERALL WIDTH IS 27 5/8"
- USABLE WIDTH IS 23 9/16"
- OVERALL LENGTH IS 34 1/16"
- USABLE LENGTH IS 20 5/8"
- OVERALL HEIGHT IS 50"
- PLATFORM HEIGHT IS 20"
- COLOR IS VESTIL BLUE
- STEP TYPE IS GRIP STRUT
- CLIMB ANGLE IS 58°
- STEP DEPTH IS 7"
- PLATFORM DEPTH IS 14"
- MAX CAPACITY IS 350 LBS
- FRONT Ø2" DIRECTIONAL SPRING-LOADED SWIVEL CASTERS
- REAR Ø3" SWIVEL LOCK CASTERS

NOTE

SOME ASSEMBLY REQUIRED
TOOL TRAY SOLD SEPARATELY

SPECIAL FEATURES

NONE

APPROVAL

I, THE UNDERSIGNED, AGREE THAT THE PRODUCT AS REPRESENTED SATISFIES DESIGN AND DIMENSION REQUIREMENTS. I ALSO ACKNOWLEDGE MY DUTY TO CONFIRM PRODUCT AND INSTALLATION COMPLIANCE WITH ALL APPLICABLE FEDERAL, STATE AND LOCAL REGULATIONS AND STANDARDS.

ALL SPECIAL UNITS ARE NON-RETURNABLE

[] As drawn [] As marked

Signed: _____ Date: _____

LEAD TIME WILL START UPON RECEIPT OF SIGNED APPROVAL DRAWING

FOR INTERNAL USE ONLY PROJECT SIGN OFF	
SALES	
ENG.	
FAB.	
POWER	

DISTRIBUTOR'S NAME:		P.O.#
VESTIL MANUFACTURING		X
DRAWN BY:	DATE:	W.O.#
B.NOETHNAGEL	9/2/2015	X
REFERENCE:	SCALE:	SALES:
X	1:14	X
QUOTED LEAD TIME:	QUOTE #	FILE NAME:
X	X	44-007-452