

ECONOMY SPREADER BEAM W/ MAGNETIC LIFTERS - SBM-10-8-ML

APPROX WEIGHT: 147.87 lbs.
 DOES NOT INCLUDE WEIGHT OF POWER OR PACKAGING!!!

*** ANY ADDITIONS, DELETIONS, OR OMISSIONS MUST BE CORRECTED ON THIS DRAWING AS THIS DRAWING WILL BE CONSIDERED ALL INCLUSIVE ***

ALL GRAPHICS PROVIDED ARE FOR REFERENCE ONLY. IF CERTAIN DIMENSIONS ARE CRITICAL PLEASE VERIFY THOSE DIMENSIONS WITH YOUR SALESPERSON

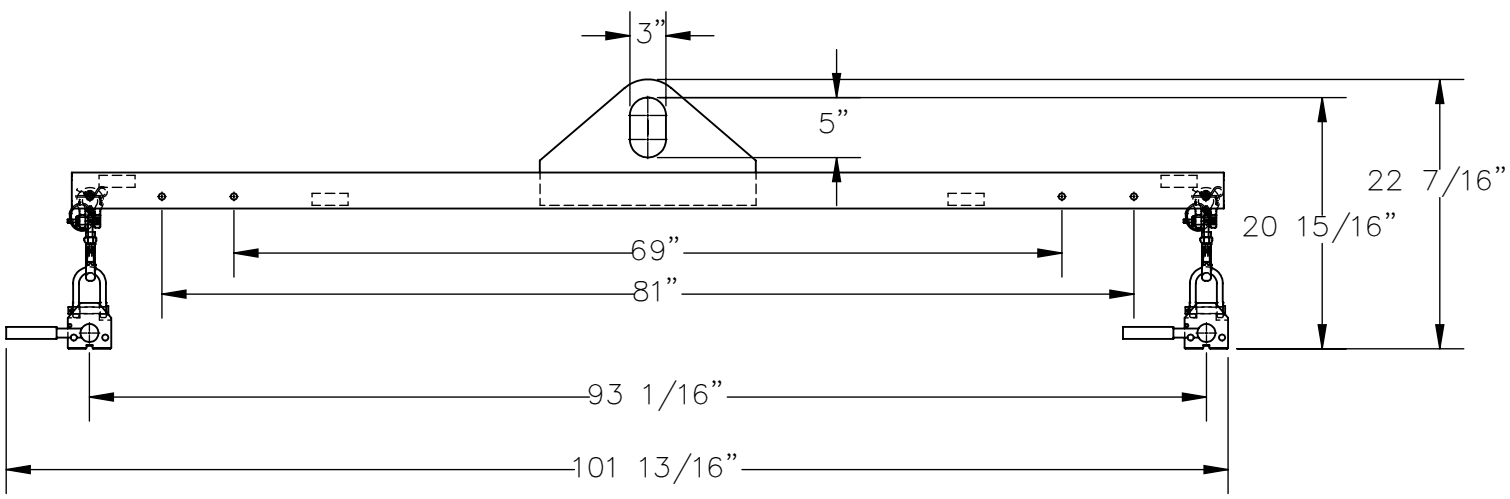
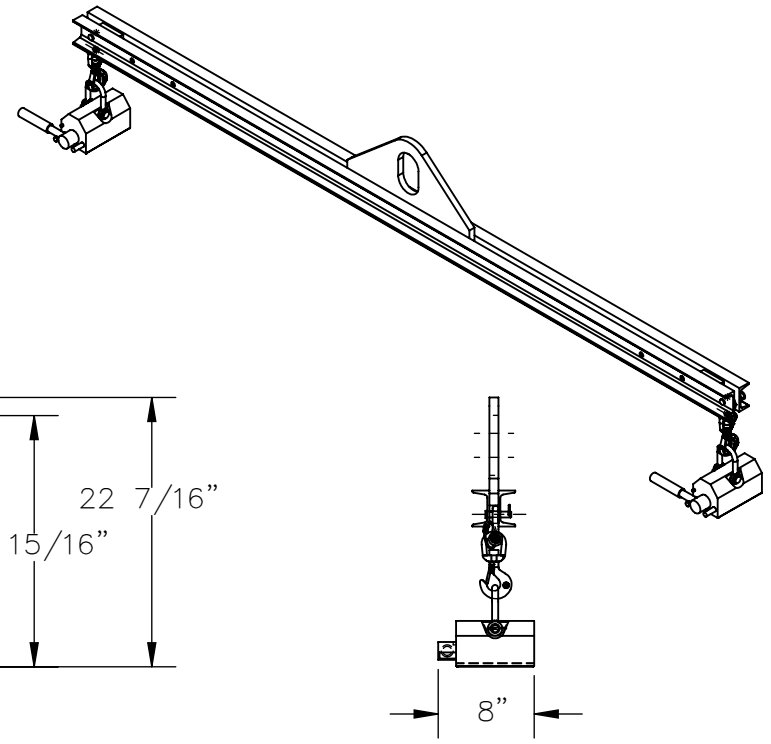

DIMENSION TOLERANCE ± 1/4"

STANDARD FEATURES

- MODEL NUMBER IS SBM-10-8-ML
- OVERALL WIDTH IS 8"
- OVERALL HEIGHT IS 22 7/16"
- OVERALL LENGTH IS 101 13/16"
- USABLE BAIL IS 3"x5"
- MINIMUM SPREAD IS 69"
- MAXIMUM SPREAD IS 93 1/16"
- HEADROOM IS 20 15/16"
- MAX UNIFORM FLAT CAPACITY IS 1000 LBS.
- MAX UNIFORM ROUND CAPACITY IS 400 LBS.
- SPREADER BEAM TOUGH BAKED IN POWDER COAT BLUE FINISH
- MAGNET LIFTERS TOUGH BAKED IN POWDER COAT YELLOW FINISH

SPECIAL FEATURES

NONE

APPROVAL

I, THE UNDERSIGNED, AGREE THAT THE PRODUCT AS REPRESENTED SATISFIES DESIGN AND DIMENSION REQUIREMENTS. I ALSO ACKNOWLEDGE MY DUTY TO CONFIRM PRODUCT AND INSTALLATION COMPLIANCE WITH ALL APPLICABLE FEDERAL, STATE AND LOCAL REGULATIONS AND STANDARDS.

ANY MODIFIED UNITS ARE NON-RETURNABLE

[] As drawn [] As marked

Signed: _____ Date: _____

Printed Name: _____

LEAD TIME WILL START UPON RECEIPT OF SIGNED APPROVAL DRAWING

FOR INTERNAL USE ONLY PROJECT SIGN OFF	
SALES	
ENG.	
FAB.	
POWER	

DISTRIBUTOR'S NAME:		P.O.#
VESTIL MANUFACTURING		X
DRAWN BY: JGP		W.O.#
DATE: 03/30/2020		X
REFERENCE: X	SCALE: 1:16	SALES: X
QUOTED LEAD TIME: X	QUOTE #	FILE NAME:
	X	08-007-448